



Operating instructions for condenser tumble dryer T 560 C

It is essential to read these operating instructions before installing or using the machine to avoid the risk of accident, or damage to the machine.



M.-Nr. 04615790

Contents

| | |
|---------------------------------|---|
| Guide to the appliance. | 3 |
|---------------------------------|---|

For the user

| | |
|--|----|
| Warning and safety instructions. | 5 |
| Notes on laundry care | 7 |
| Loading and unloading washing | 8 |
| Programme selection | 9 |
| Programmes for Cottons | 10 |
| Programmes for Minimum iron and timed drying | 11 |
| Programmes - Consumption data | 12 |
| Emptying the condensed water container | 13 |
| Cleaning and care | 14 |
| Problem solving guide | 17 |
| After sales service | 19 |

For the installer/electrician

| | |
|---------------------------------|----|
| Installation | 20 |
| Electrical connection | 21 |
| Condensed water outlet. | 23 |
| Technical Data | 25 |

Help to protect our environment!

Disposal of the packing material

The packaging used to protect the machine during transport largely consists of the following recyclable materials:

- Corrugated paper/card
- Polystyrene - CFC-free
- Polyethylene foil - transparent
- Fibreboard (solvent free)
- Untreated wood
- Packaging straps: Polyamide (blue); Polypropylene (black)

Rather than just throwing these materials away please take them to the nearest collection point for specific waste.

Disposal of your old appliance

Old appliances contain materials which can be recycled. Please contact your local authorities or scrap merchant about potential recycling schemes, before disposing of the appliance.

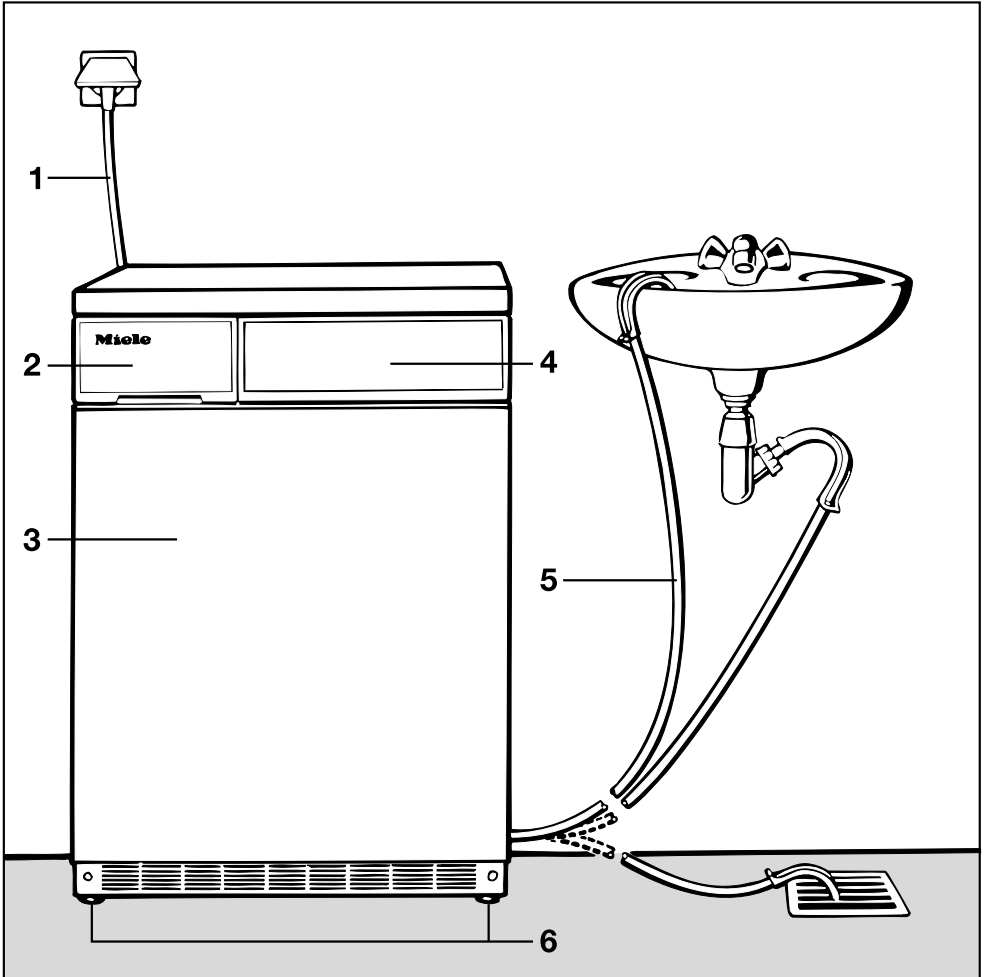

- 1** a.c. connection cable (2 m long)
- 2** Condensed water container
- 3** Drum door
- 4** Control panel
- 5** Drain hose for condensed water
- 6** Four height-adjustable screw feet

Guide to the appliance

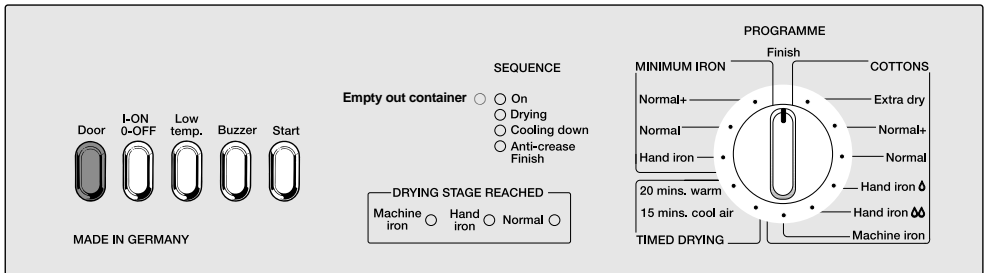

Pushbuttons

Door

opens the door

On/Off

for switching the appliance on and off.

Low temperature

low temperatures for delicate fabrics, e.g. acrylics.

Buzzer

sounds when the drum turns during the intermittent anti-crease action period.

Start

starts a drying programme

Indicator light “Empty out container”

Programme sequence indicator lights

On

Drying

Cooling down

Anti-crease/Finish

Programme selector switch

Cottons

Extra dry

Normal+

Normal

Hand iron 

Hand iron 

Machine iron

Minimum iron

Normal+

Normal

Hand iron

Timed drying

15 mins cool air

20 mins warm air

Drying stage display

This shows the stage of drying reached. For programmes “Normal +” and “Extra dry” the indicator light remains at the “Normal” position.

Environmentally conscious drying

The sensitive system automatically adjusts drying to suit the water quality. The water conductivity is measured, and registered by the control which then compensates to achieve a uniform residual moisture level. The Novotronic control offers 9 programmes with electronic moisture measuring and 2 timed programmes. The automatic reversing action turns the drum clockwise and anti-clockwise to loosen the laundry and prevent damp patches and thus to ensure even drying results.

Energy saving tips

Make sure that your laundry is thoroughly spun before drying. You will save up to 35% energy and time if laundry is spun at full spin speed instead of at 600 rpm. Load according to the optimum amount of washing for the programme to be selected. Underloading is uneconomical. Overloading gives a poorer quality of drying and may cause unnecessary creasing.

Before using for the first time

Important: The appliance must be properly installed and connected to the electricity supply.

Warning and safety instructions

Please read the operating instructions before using the tumble dryer for the first time. They contain important information about the safety, use and maintenance of the machine. This will avoid the risk of accidents and damage to the machine. Keep these operating instructions in a safe place and ensure that new users are familiar with the content. Pass them on any future owner of the machine.

Correct usage

■ The tumble dryer is only intended for drying fabrics, which have been washed in a water solution, marked on the manufacturer's wash care label as being suitable for tumble drying. Any other applications may be dangerous. The manufacturer is not

liable for damage resulting from improper use or operation.

■ Do not let small children play with the machine and its controls or operate it. Please supervise its use by the elderly or infirm.

Technical safety

■ Before connecting the machine, ensure that the connection data on the data plate (fusing, voltage and frequency) matches the mains electricity supply. If in any doubt, consult a qualified electrician.

■ Faulty components must only be exchanged for Miele original spare parts. Only when these parts are fitted can the safety standards of the machine be guaranteed.

Warning and safety instructions

■ The electrical safety of this machine can only be guaranteed when continuity is complete between the appliance and an effective earthing system which complies with local and national regulations. It is most important that this basic safety requirement is regularly tested by a qualified electrician. The manufacturer can not be held responsible for the consequences of an inadequate earthing system.

■ The machine is built in accordance with current safety requirements. Unauthorised repairs could result in unforeseen dangers for the user, for which the manufacturer can not accept responsibility. Repairs should only be undertaken by a Miele approved engineer.

■ In the event of a fault or for cleaning purposes, the machine is only completely isolated from the electricity supply either when:

- the plug is withdrawn, or
- it is switched off at the mains
- the mains fuse is withdrawn.

Use

■ There is a danger of fire with fabrics, which:

- contain rubber, foam rubber or rubber-like materials
- have been treated with inflammable cleaning agents
- have been splashed with hair lacquer, hair spray, nail varnish remover or similar.

■ Always close the door after use. This way you will avoid the danger of anyone sitting or leaning on the door, which can cause the machine to tip up.

■ Do not install the machine in a room where the temperature may drop below freezing. At very cold temperatures the machine may be difficult to start. At very cold temperatures the machine may be difficult to start. Laundry will not dry and the “anti-crease” indicator light will flash to indicate there is a problem. Freezing condensed water in the pump, hoses and in the condensed water container can lead to damage.

■ Make sure the drain hose is securely attached if you hang it in a sink or basin (external drainage of condensed water) to avoid the hose slipping and the water causing damage.

■ Condensed water is not drinking water. It can cause health problems in people and animals.

Using accessories

■ Accessory parts may only be fitted when expressly approved by Miele. If other parts are used, guarantee, performance and product liability claims may be invalidated.

Disposal of your old machine

■ Before discarding an old machine unplug it. Render the plug useless. Cut off the cable directly behind the appliance to prevent misuse.

Before drying, check the drying symbol on the textile care label.

Significance of symbols:

- ☉ = Dry at normal temperature
- ☉ = Dry at low temperature
- ☒ = Do not tumble dry

If no symbol is featured dry at your own risk applying the following principles:

- Cottons and minimum iron items should be dried at a normal temperature at the appropriate programme setting.
- For delicate fabrics, e.g. acrylic fibres, the low temperature setting should be selected.

The following fabrics should not be dried in a tumble dryer:

- Woollens and wool blends
These fabrics tend to become matted and shrink.
- Items filled with down
The fine fabric interior tends to shrink, depending on the quality involved.
- Pure linen
These items should only be machine-dried if specified as suitable by the manufacturer on the textile care label, as the surface of the fabric may otherwise tend to “roughen”.

Note

Some woven and loopknit materials tend to shrink to varying extents depending on their quality. This tendency is exaggerated by over-drying.

When purchasing woven materials, it is advisable to take their shrinkage properties into account.

Starched washing can also be dried in the tumble dryer. In order to achieve the usual finish, double the amount of starch should be used.

Select the most suitable programme for hand or machine ironing.

Minimum iron items should be spun for 10 to 30 seconds before being tumble dried. Such fabrics tend to crease if overdried. These items should be given only a short period in the dryer, and taken out slightly damp. The “Minimum iron Normal” programme is recommended.

Minimum iron shirts in 100 % cotton may crease during tumble drying depending on the quality and weave.

Minimum iron fabrics tend to crease more, the greater the load. This is particularly true of very delicate fabrics. The load should be reduced to 1.5 kg or, if necessary, to 1 kg. The “Hand iron” setting is recommended for these types of garment. In extreme cases do not tumble dry these garments.

Dark-coloured garments should be dried separately from light-coloured garments.

Loading the machine

Load the laundry very loosely into the drum.

Duvet covers and pillowcases should be fastened before drying in order to prevent small items from being rolled inside them.

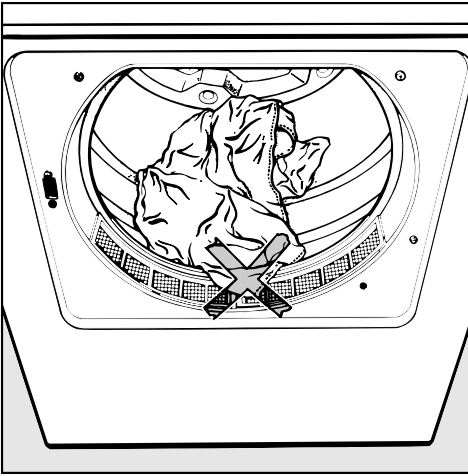

Important: Please check that items of laundry cannot be trapped by the door as this will cause damage to the fabric.

Unloading the machine

At the end of the programme remove the washing from the machine. If this is not done, the machine automatically proceeds into an intermittent anti-crease action for 60 minutes. This entails the drum being rotated at short intervals in order to reduce the possibility of the formation of creases.

Once the laundry has been removed, check that the drum is empty. Any items left in the drum could be damaged through overdrying in the next programme.

Clean the fluff filter after each drying cycle to prevent excessive energy consumption and longer programme running times.

The door should always be closed after use.

Selecting a programme

This tumble dryer is fitted with an electronic sensor system. The required degree of dryness is measured and monitored electronically so that the heating element is switched off as soon as it is reached. The drying cycle automatically finishes with a cooling down period. This may be followed by the anti-crease action cycle.

The following drying programmes are available:

– **Cottons**

six drying levels from “Extra dry” to “Machine iron”

– **Minimum iron**

three drying levels from “Normal+” to “Hand iron”

– **Timed drying**

15 mins cool air and 20 mins warm air

Low temperature

By selecting “Low temperature” the temperature can be lowered for delicate fabrics (e.g. acrylic).

Correct procedure:

- Switch on the machine.
- Press the "Door" button.
- Load the drum.
- Close the door with a firm swing - do not push it shut.
- Select a programme by turning the selector switch clockwise or anti-clockwise.
- Select “Low temperature” if required.
- Press “Start”.

After drying:

- Turn the programme selector switch to “Finish”.
- Switch the machine off.
- Clean the fluff filter.

Opening the door during a programme

If the door is opened during a programme the programme will have to be started again:

- Close the door.
- Press “Start”.

The selected programme restarts.

The programme is not continued if:

- There is a power failure lasting more than 30 minutes.
- The programme has already reached the “Cooling down” or “Anti-crease” stage.

To reselect a different programme during drying:

- Set the programme selector switch to the required programme.
- The new programme starts from the beginning.

To cancel a programme

- Turn the programme selector switch to “Finish”.

Programmes - Cottons

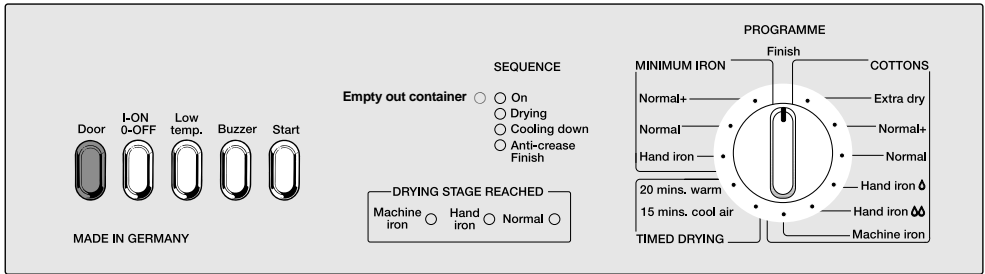

Extra dry

Multi-layer fabrics which would not be thoroughly dried using the “Normal +” programme.

max. 5 kg

Note:

Jerseywear tends to shrink depending on the quality and type of manufacturing involved. The “Extra dry” programme should therefore not be selected for these fabrics.

Normal+

Mixed load of cotton fabrics, e.g. towelling and jerseywear, i.e. single-layer and multi-layer fabrics.

max. 5 kg

Normal

Homogeneous loads of cotton fabrics (jerseywear, flannelette sheets, towelling).

max. 5 kg

Note:

Should certain items still be slightly damp, select the “Normal + programme”.

Hand iron

Cotton or linen fabrics, e.g. table linen, bedding, starched laundry, etc.

max. 5 kg

Note:

If fabrics are too damp for hand-ironing, please select the “Hand iron ” programme.

Machine iron

Cotton or linen fabrics, including starched laundry, for machine-ironing.

max. 5 kg

Note:

The laundry should be rolled up to prevent it from drying out until it can be ironed.

Programmes - Minimum iron and timed drying

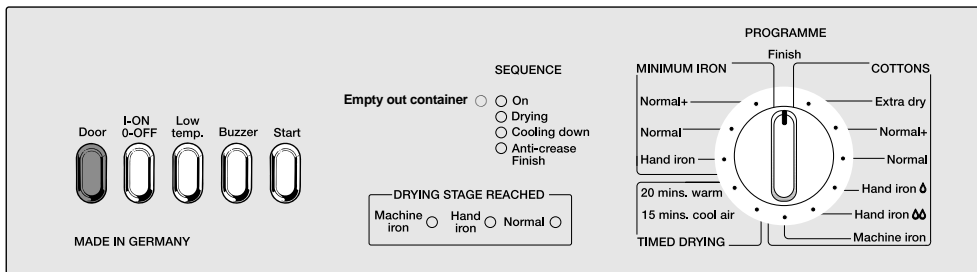

Normal +

Minimum iron items made of synthetics or blended fabrics, e.g. pullovers, dresses, trousers, etc., which are not dried adequately in the "Normal" programme.

max. 2.5 kg

Normal

Minimum iron shirts, table cloths, etc., made of blended woven or knitted fabrics, e.g. cotton/synthetics.

max. 2.5 kg

Hand iron

Minimum iron shirts, table cloths, etc. made of blended woven or knitted fabrics, e.g. cotton/synthetics, which are still to be hand-ironed.

max. 2.5 kg

Note for all three programmes:

With blended fabrics consisting of wool and synthetics, consult the manufacturer's instructions, as the wool component may become matted.

15 minutes cool air

Items which are only to be aired.

max. 5 kg

20 minutes warm air

Individual items, e.g. bathing towels, bathing trunks.

Programmes - Consumption data

| | Capacity | Final spin speed in a domestic washing machine | Electricity consumption | Drying time incl. cooling down time |
|---------------------|----------|--|-------------------------|-------------------------------------|
| | kg | rpm | kWh | mins |
| Cottons | | | | |
| Extra dry | 5 | 1200 | 3.44 | 87 |
| | | 1400 | 3.28 | 83 |
| | | 1550 | 3.17 | 81 |
| Normal + | 5 | 1200 | 3.17 | 81 |
| | | 1400 | 3.02 | 77 |
| | | 1550 | 2.91 | 75 |
| Normal * | 5 | 800 | 3,60 | 92 |
| Normal | 5 | 1200 | 2.82 | 74 |
| | | 1400 | 2.68 | 71 |
| | | 1550 | 2.58 | 69 |
| Hand iron ∆∆ | 5 | 800 | 2,80 | 74 |
| Hand iron ∆∆ * | 5 | 1200 | 2.05 | 56 |
| | | 1400 | 1.91 | 53 |
| | | 1550 | 1.82 | 51 |
| Machine iron | 5 | 1200 | 1.65 | 47 |
| | | 1400 | 1.51 | 43 |
| | | 1550 | 1.41 | 41 |
| Minimum iron | | | | |
| Normal + | 2.5 | 1000 | 1.68 | 50 |
| Normal * | 2.5 | 1000 | 1.38 | 45 |
| Hand iron | 2.5 | 1000 | 1.21 | 37 |

Emptying the condensed water container

During the programme, water is condensed and collected in a container on the left behind the fascia panel. The container holds approx. 4 litres and should be emptied after each drying programme.

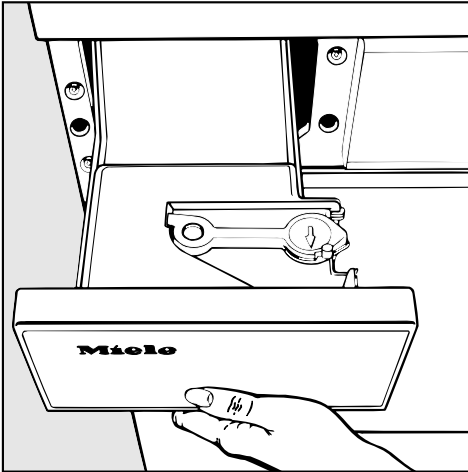

- Pull out the container

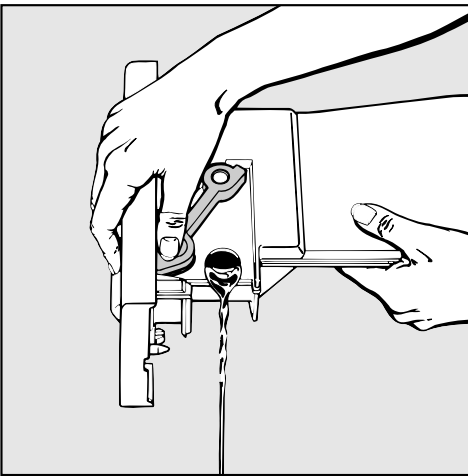

- Pull forward the cap of the spout as indicated by the arrow and hold open while emptying the container.

- When the container is empty, release the cap. The spout closes automatically.
- Push in the container until it clicks into place.

Should the container be inadvertently full when the tumble dryer is started or if it becomes full during operation:

- The “Empty out container” indicator light comes on

Note:

The water collected in the container has been distilled by evaporation and can be used in a steam iron or humidifier, for example.

The following points should be remembered:

The laundry should be thoroughly rinsed before it is loaded in the tumble dryer.

As a precautionary measure, the water should be passed through a fine sieve or coffee filter in order to strain out any very small particles of fluff from the water which might otherwise cause damage.

Cleaning and care

The fluff which occurs during drying is collected in the fluff filter in the door.

Clean the filter after every programme to save time and energy.

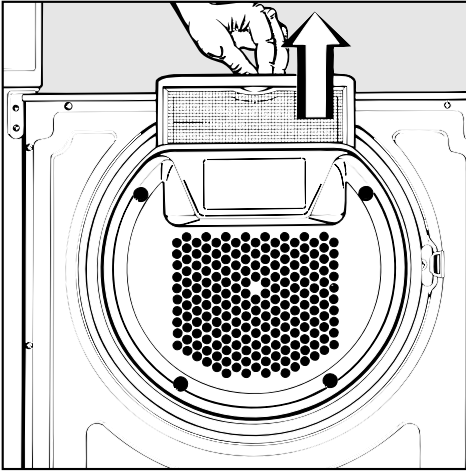

- Grip the filter by the recessed handle and pull upwards to clean.
- Remove any remaining fluff from the hollow part of the door through the wide slit at the bottom.

All filters can rinsed with water if necessary.

- Dry the filters before putting them back in place.

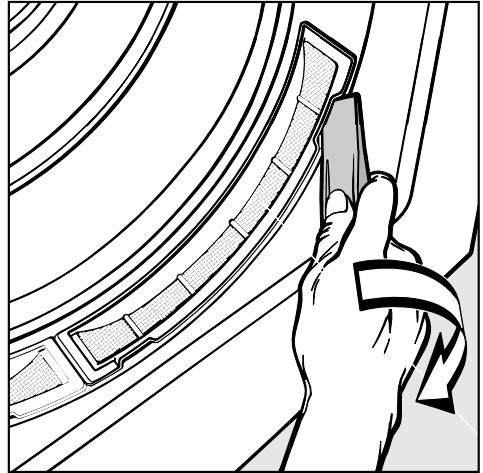

- Remove fluff from the filters in the door opening. These filters can be taken out and rinsed if necessary.
- Dry the filters before putting them back in place.

Before cleaning the tumble dryer: Always disconnect the machine from the power supply.

- The dryer can be cleaned with a cloth using soapy water or a mild detergent (not scouring powder) and dried with a soft cloth.
- The drum may be cleaned using a suitable proprietary stainless steel cleaner following the manufacturer's instructions.

The machine must never be hosed down.

Do not use any abrasive cleaners, or glass or all-purpose cleaners. These might cause damage to the plastic surfaces because of the chemicals they contain.

Heat exchanger

The heat exchanger should be cleaned once or twice a year.

Before cleaning, disconnect the machine from the mains supply.

- Open the door

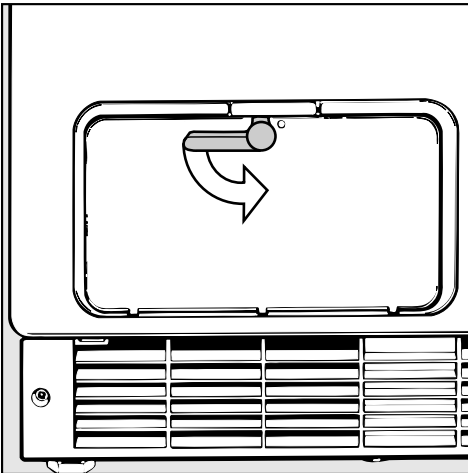

- Turn the flap lever so that it is vertical

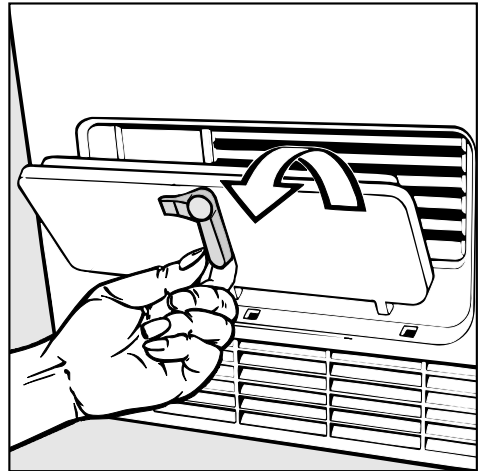

- Remove the flap

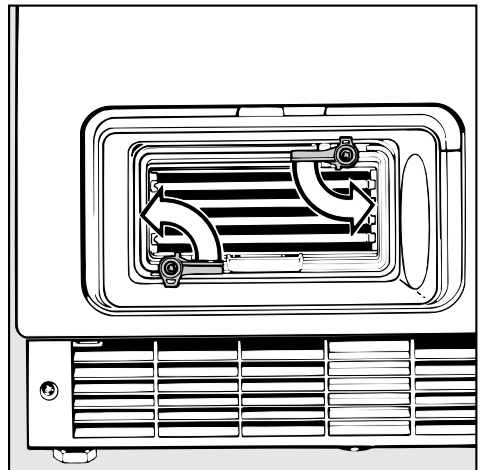

- Turn both levers on the heat exchanger so that they are vertical

Cleaning and care

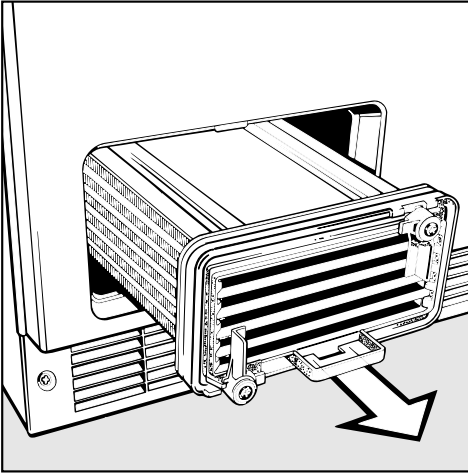

- Pull out the heat exchanger

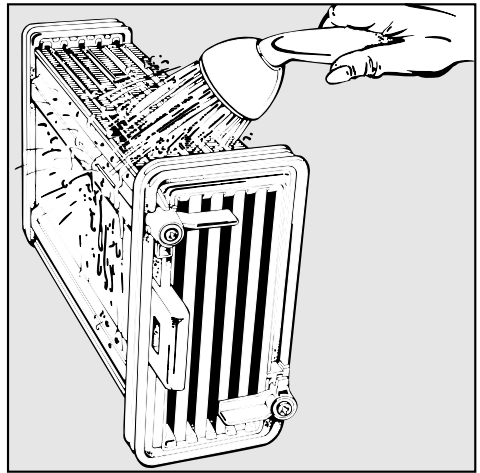

- and along the two long sides

- Stand the heat exchanger lengthwise on a towel until it is quite dry
- Replace the heat exchanger in the reverse order.

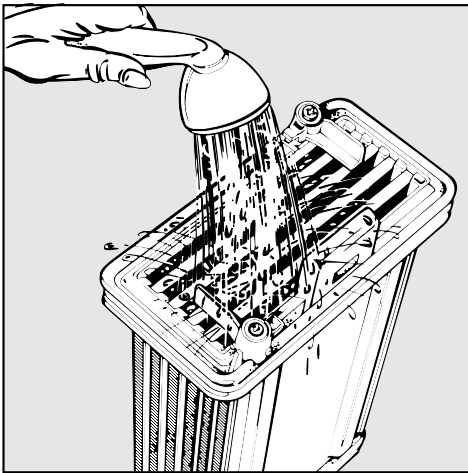

- Clean the heat exchanger:

- at both ends (front and back)

Attempt to pull forward the heat exchanger and the flap to check that both are firmly positioned, as otherwise water may leak from the machine.

Electrical appliances should only be repaired by qualified personnel. Incorrectly repaired machines may pose a considerable risk to the user.

There are, however, minor faults which can be corrected without contacting the Service Department.

The tumble dryer fails to start when switched on.

Check whether the "On" indicator lamp lights up. If so, failure to start may be due to an incorrect selection procedure sequence when switching on the machine.

- Repeat the switch-on procedure in the correct sequence (see P. 9).

If the "On" indicator lamp does not light up, check that

- the "On/Off" button is depressed
- the door is properly closed
- the mains plug is plugged in and the fuse or circuit breaker has not tripped.

Laundry is not sufficiently dry.

The load consists of dissimilar items in terms of size and fabric.

- Select a longer drying programme next time.

Small loads or individual items may cause the programme to terminate prematurely.

- Small loads should therefore be "time-dried".

Drying times are too long.

- Clean the fluff filter in the door.

The laundry was not spun for a sufficiently long time.

The grille under the drum door is blocked, preventing any intake of cool air.

Ventilation is inadequate (e.g. in a small room).

- When the machine is in operation, open a door or the window.

After cleaning the heat exchanger, water leaks from the machine

- Check that the heat exchanger flap has been replaced correctly. If necessary, remove and replace.

Items made of synthetic fibres are charged with static electricity after drying.

Static charge can be reduced by adding fabric conditioner during the final rinse cycle in the washing machine, or a fabric conditioner sheet in the tumble dryer.

Formation of fluff

Fluff is principally the result of friction when items are worn and washed. Machine-drying hardly causes any fluff to form and, as has been established by research institutes, has no effect on the lifetime of fabrics.

Problem solving guide

To open the door in the event of power failure

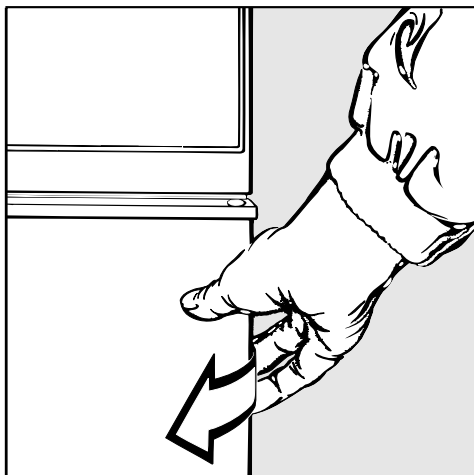

Water droplets appear at the upper edge of the drum aperture.

A double filter system with double seal prevents fluff from being deposited in the heat exchanger.

This means that the heat exchanger does not need to be cleaned so often.

The double seal may lead to the build-up of condensate. Laundry being removed from the machine may come into contact with these water droplets. They will, however, dry off in a matter of minutes.

The light ring do not illuminate

The bulb has gone. Please contact your Miele Costume Service Dept. for advice on how to change the bulb. The functioning of the machine is no way affected.

The “Anti-crease” indicator lamp in the sequence indicator display starts flashing.

- Release the “On/Off” button and then press it in again.
- Press the “Start” button.

If the indicator lamp starts flashing again, this indicates a fault in the machine. Please then contact your Miele Dealer or the Miele Service Dept.

The drum door opens during the drying cycle.

The machine has overheated. The temperature limiter opens the drum door and thus causes the machine to switch off automatically.

Possible reasons for overheating:

- The fluff filters in the door and in the door opening are clogged.
- The heat exchanger is blocked. Before restarting the programme, proceed as follows:
 - Clean the affected part of the machine.
 - Press the “Start” button.

Should the drum door open again, this must be due to a technical fault and the Service Dept. should be contacted.

The interior drum lighting fails to function.

The bulb may be defective.
Replace it as follows:

- Switch off the machine or disconnect from the mains supply.
- Open the door.

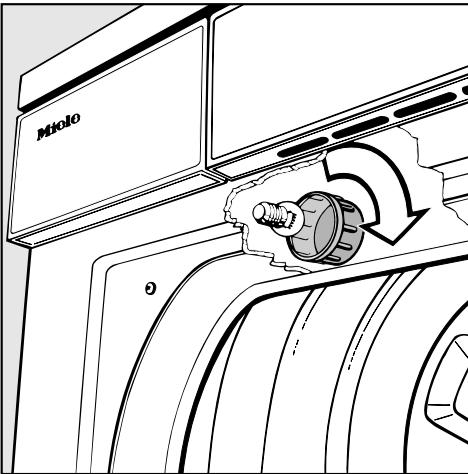

- Use a 19 mm spanner to unscrew the plastic cover inside the drum above the door.

The light bulb must not exceed the maximum wattage quoted on the data plate and the plastic light cover.

- Replace the bulb and the plastic cover.

The cover must be fixed securely, as otherwise moisture may seep in and cause a short-circuit.

The temperature-resistant bulb should only be ordered from your Miele Dealer or the Service Dept.

In the event of any faults which cannot be remedied, or if the appliance is under guarantee, please contact:

- your Miele Dealer or
- the nearest Miele Service Department (see back cover for the address).

When contacting the Service Department, please quote the Model and Serial nos. of your appliance, both of which are shown on the data plate on the right hand side below the opening to the drum.

Example:



Installation

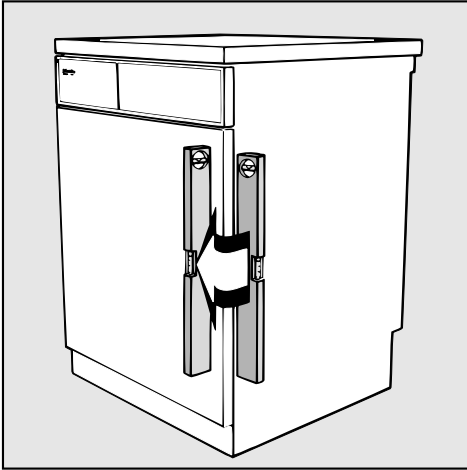

The machine must be perfectly level to ensure safe and proper operation. Minor differences do not, however, have an adverse effect on operation.

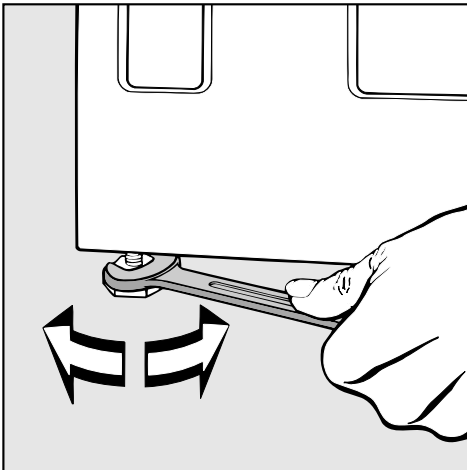

- The screw feet can be adjusted to compensate for any unevenness in the floor surface.

Important

The grille below the drum door should never be blocked, as this will prevent a sufficient intake of cold air.

Installation

It is possible to install this appliance under a continuous worktop / in a row of kitchen units using a special conversion kit*. The machine lid is replaced by a coverplate which must be fitted by a suitably competent person to ensure electrical safety.

When installing under a worktop with a working height of 900/910 mm: a spacer kit * is needed.

When built under, the programme running times may be longer.

The tumble dryer can also be combined with a Miele washing machine in a washer-dryer stack. For this purpose the appropriate stacking kit * to match your washing machine is required.

* These items are all available from your Miele Dealer.

For U.K. only:

This tumble dryer is supplied ready for connection to an a.c. single phase 230 V, 50 Hz supply. The rated load is 2.9 kW. The machine is supplied with a 2 m long mains cable with moulded plug and the fuse rating is 13 A. The appliance should be connected up only by a qualified electrician, in accordance with national and local safety regulations.

For other countries:

This tumble dryer is supplied ready for connection to an a.c. single phase 220 V, 60 Hz supply. The rated load is 2.86 kW. The machine is supplied with a 2 m long mains cable with moulded plug and the fuse rating is 16 A. The appliance should be connected up only by a qualified electrician, in accordance with national and local safety regulations.

Connection should be made via a fused plug and a suitable switched socket which is easily accessible. For extra safety it is advisable to install a residual current device (RCD) with a trip current of 30 mA. The voltage, rated load and fuse rating are given on the data plate. Please ensure that these match the household mains supply.

Important

The wires in the mains lead are coloured in accordance with the following code:

Green/yellow = earth

Blue = neutral

Brown = live

As the colours of the wires in the mains lead of this appliance may not correspond with the coloured markings identifying the terminals in your plug, pro-

ceed as follows:

The wire which is coloured green and yellow must be connected to the terminal in the plug which is marked with the letter E or by the earth symbol \perp or coloured green or green and yellow. The wire which is coloured blue must be connected to the terminal which is marked with the letter N or coloured black. The wire which is coloured brown must be connected to the terminal which is marked with the letter L or coloured red.

WARNING

THIS APPLIANCE MUST BE EARTHED.

Non-rewireable plugs BS 1363 (U.K.)

If this machine or appliance is fitted with a non-rewireable plug, the following information applies:

If the socket outlets are not suitable for the plug supplied with this product, it must be cut off and an appropriate plug fitted. The plug cut from the flexible cord should be disposed of and on no account be inserted into a 13 A socket elsewhere in the house (electric shock hazard). The fuse cover must be refitted when changing the fuse, and if the fuse cover is lost, the plug must not be used until a suitable replacement is obtained. The colour of the correct replacement cover is that of the coloured insert in the base of the plug, or the colour that is embossed in words in the base of the plug (as applicable to the design of plug fitted). The correct fuse rating of the replacement fuses that are ASTA approved to BS 1362 should be fitted. Replacement fuse covers may be purchased from your local electrical suppliers, electricity showroom, or Miele Service Agent.

Electrical connection

Electrical connection AUS

This tumble dryer is supplied ready for connection to an a.c. single phase 240 V, 50 Hz supply. The rated load is 2.4 kW. The machine is supplied with a 2 m long mains cable with moulded plug and the fuse rating is 10 A.

The appliance should be connected up only by a qualified electrician, in accordance with national and local safety regulations.

Important

The wires in the mains lead are coloured in accordance with the following code:

Green/yellow = earth

Blue = neutral

Brown = live

As the colours of the wires in the mains lead of this appliance may not correspond with the coloured markings identifying the terminals in your plug, proceed as follows:

The wire which is coloured green and yellow must be connected to the terminal in the plug which is marked with the letter E or by the earth symbol  or coloured green or green and yellow.

The wire which is coloured blue must be connected to the terminal which is marked with the letter N or coloured black. The wire which is coloured brown must be connected to the terminal which is marked with the letter A or coloured red.

WARNING

THIS APPLIANCE MUST BE EARTHED.

External drainage of condensed water

The condensed water can be drained off directly if the machine is installed near a sink, drain outlet, etc.

Accessories (available from your Miele Dealer):

- 2 m drain hose
- Hose clamp
- Rubber connection sleeve
- Hose clip

Installation:

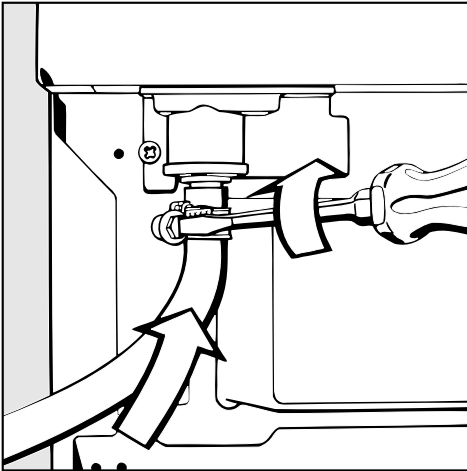

- Detach the hose clip from the drain outlet at the back of the machine and remove the rubber plug.

- Push the drain hose onto the drain outlet. Make sure that the hose is firmly secured by the clip and not kinked.

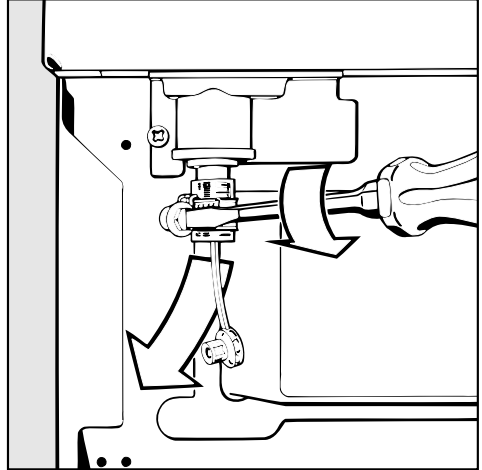

Max. drain hose length: 3.0 m

Max. delivery head: 1.0 m

External drainage of condensed water

The machine is fitted with a non-return valve as standard to prevent water from flowing back into the machine (eg. if the machine is connected to a siphon).

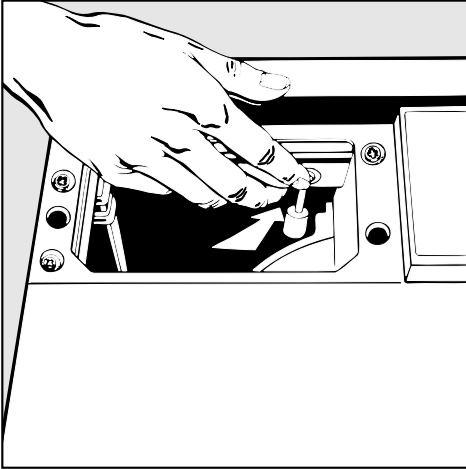

- Close the water inlet port above the condensed water container with the bottom part of the rubber plug. The plug must face towards the interior of the machine so that the condensed water container can easily be inserted.

Connection to wash basin drain outlet

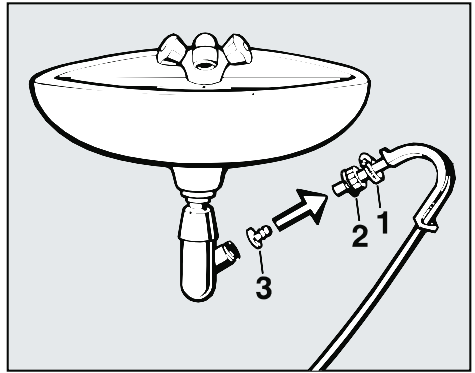

- Push the hose clip (1) and knurled nut connector (2) (from the sink drain outlet) over the drain hose.
- Put the adapter sleeve (3) supplied into the hose.
- Screw the drain hose to the drain outlet with the knurled nut connector.
- Tighten the hose clip (1) up close to the nut (2).

Technical data

| | |
|--|---------------------------------|
| Height | 85.0 cm (adjustable +1/-0.5 cm) |
| Width | 59.5 cm |
| Depth (incl. distance from wall) | 60.0 cm |
| Weight | 55 kg |
| Drum volume | 103 l |
| Capacity | 5 kg dry weight |

| | |
|-----------------------|------------------|
| Voltage | } See data plate |
| Rated load | |
| Fuse rating | |

| | |
|----------------------------------|-------|
| Max. delivery head | 1.0 m |
| Max. drain hose length | 3.0 m |

| | |
|-------------------------------------|-------------------------------|
| Test certificates awarded | Radio/ TV suppression; VDE |
| Electrically suppressed | Acc. to DIN EN 60555/VDE 0838 |

Miele

United Kingdom

Miele Co. Ltd., Fairacres, Marcham Road, Abingdon, Oxon, OX14 1TW

tel. Abingdon (01235) 554455 - fax (01235) 554477

Service Office, tel. Abingdon (01235) 554466